

Assembly Instruction

ITEM NO.:9359GRY-VC

(1/2)REVERSIBLE-CHAISE WITH
HIDDEN STORAGE

ITEM NO.:9359GRY-VT













(2/2)REVERSIBLE-2-SEATER
WITH PULL OUT BED



Parts are stored at the bottom of the seat, please take out for assembly.

Note: Do not use power tools for assembly. Power tools increase the risk of over tightening which lead to splitting or cracking the wood.

Component list (2-Seater & Chaise)

No	Drawing	Qty	Description
A		1	Lsf arm
B		1	Love Seat
C		1	Chaise
D		1	Rsf arm
E		3	Back Cushion
F		12	Plastic Leg(ø50*50mm)
G		4	Wheel(50mm)
H		8	Screw(M5*25mm)
I		12	Bolt(M8*70mm)
J		16	Flat Washer(M8)
K		1	Allen Wrench(M5)
L		4	Nut(M8)
M		1	Open spanner(M5)

Step #1 Please take out parts which stored inside the seat for assembly.

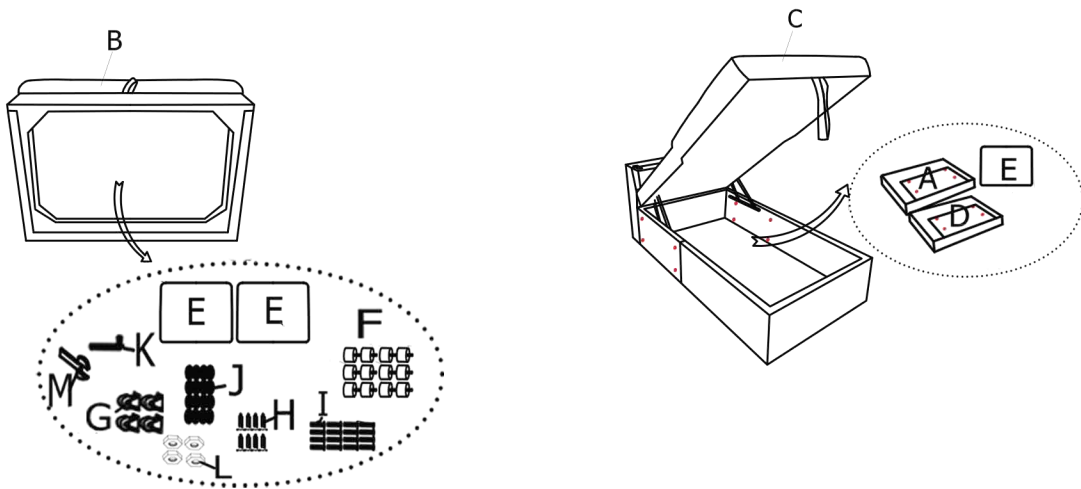

Step #2 Align legs to the pre-drilled holes, insert screws and tighten with Allen.

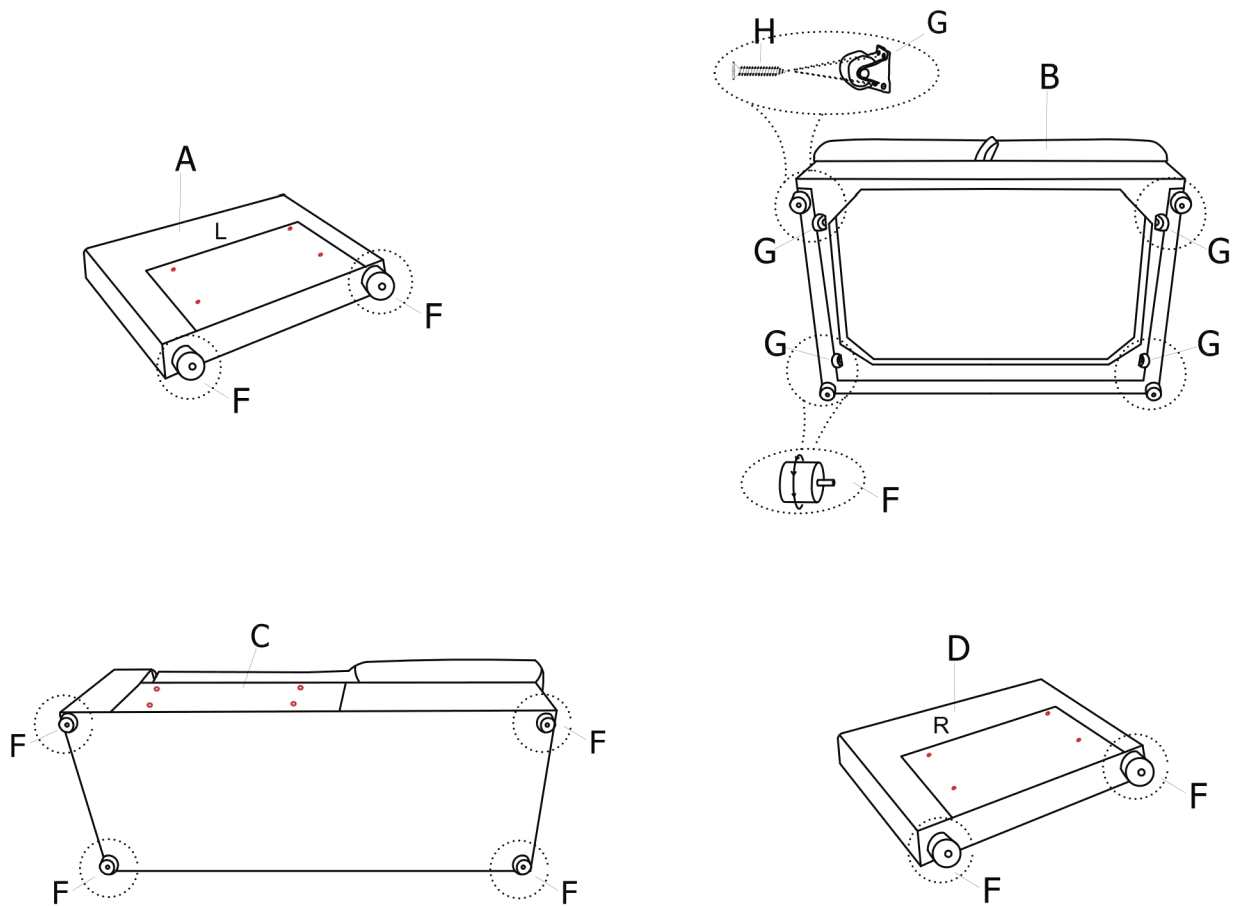

Step #3 Align and connect bolt to assemble the sectional.

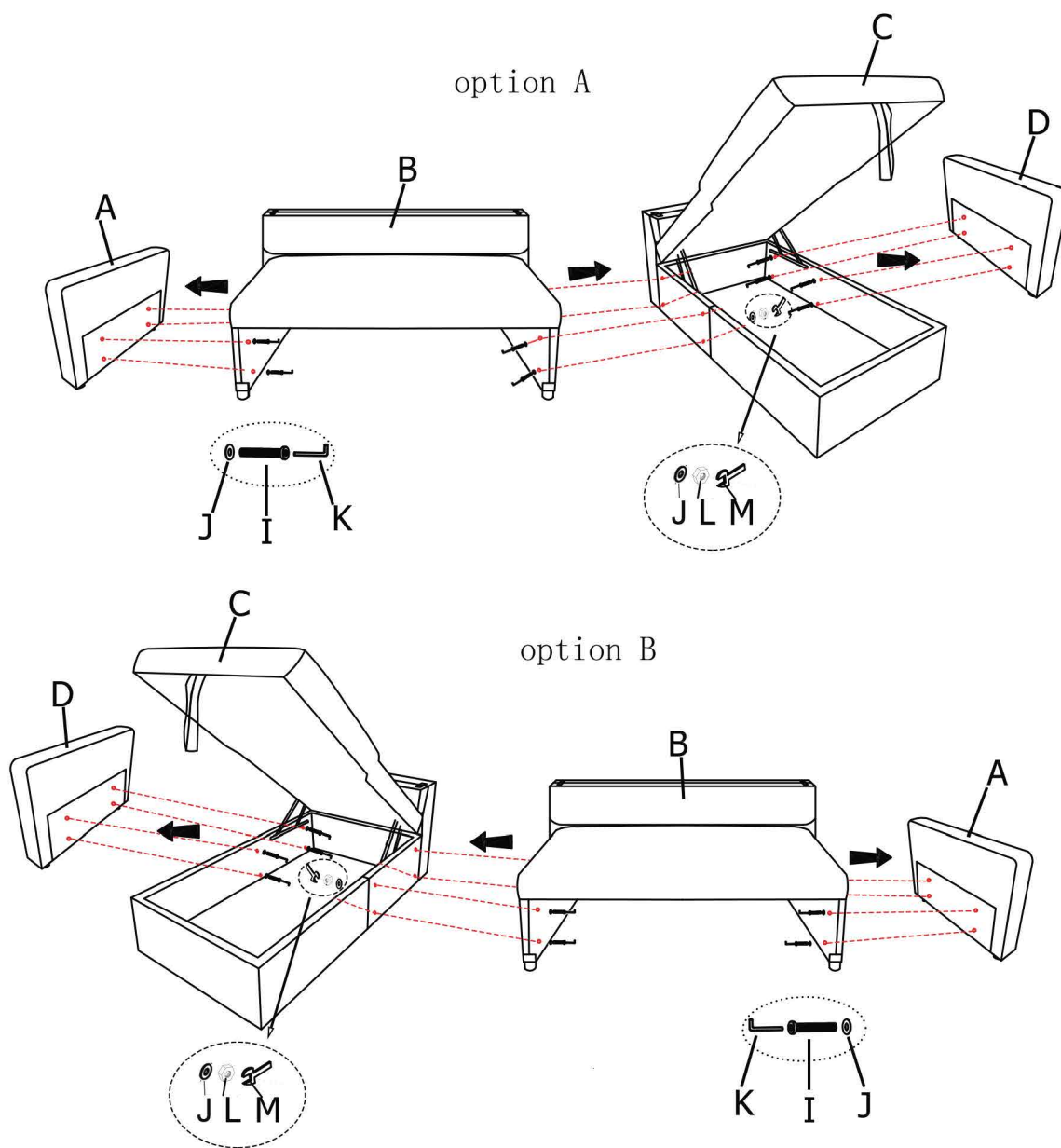

Step #4 Assemble the pull-out bed to the seat.

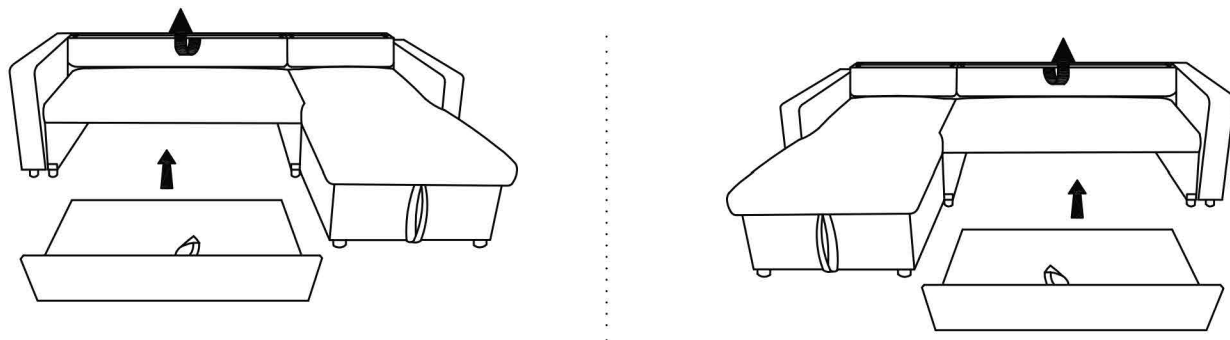

Step #5 Align back cushion onto the back rest.

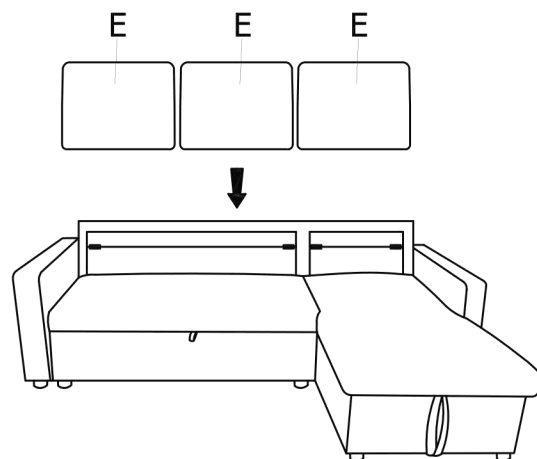
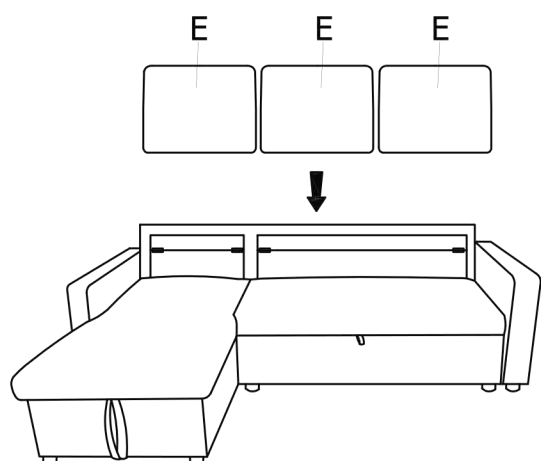

Step #6 Sectional assembly is completed.

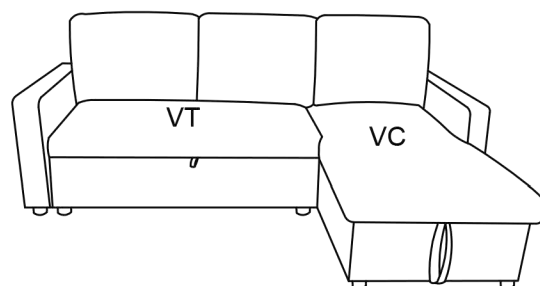
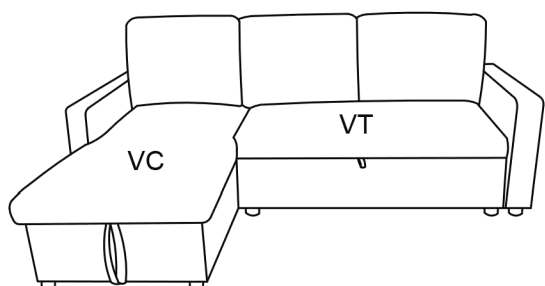

Care Instruction for Textured fabric Furniture:

In order to maintain the original appearance of your textured fabric Furniture, please follow below simple care procedures:

- Avoid exposing furniture directly to sunlight or heating and air conditioning outlets. Sunlight and or exposure to heating and air conditioning outlets will fade/damage textured fabric.
- Vacuum or wipe with a soft cloth to remove dust.



For items use on wooden floor, hard surfaces or carpets, it is recommended to Install protective pads under all legs and supports to avoid/prevent from damages/scratches and discoloration.