



H O M E E L E G A N C E

Assembly Instruction

ITEM NO.:9468BE-LC







(1/2)LSF Chaise w/ Storage

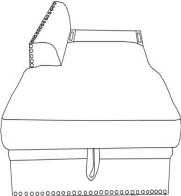
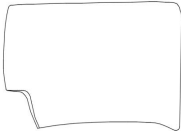
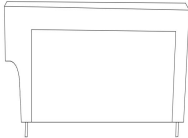

Legs and hardware and backrests are stored in chaise storage, please take for assembly.

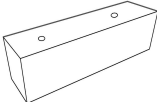
Note: Do not use power tools for assembly. Power tools increase the risk of over tightening which lead to splitting or cracking the wood

Component list .

Label	Picture	Description	QTY(pc)
E		Chaise Seat	1
F		Back Cushion	1
G		Back Rest	1
H		Round Plastic leg $\phi 1.96'' * 1.96''$	4
I		Plastic Leg $7.08'' * 1.96'' * 1.96''$	5
J		Caster	4
K		Screw $\phi 0.15'' * 1.96''$	14
L		Screw $\phi 0.15'' * 0.98''$	16

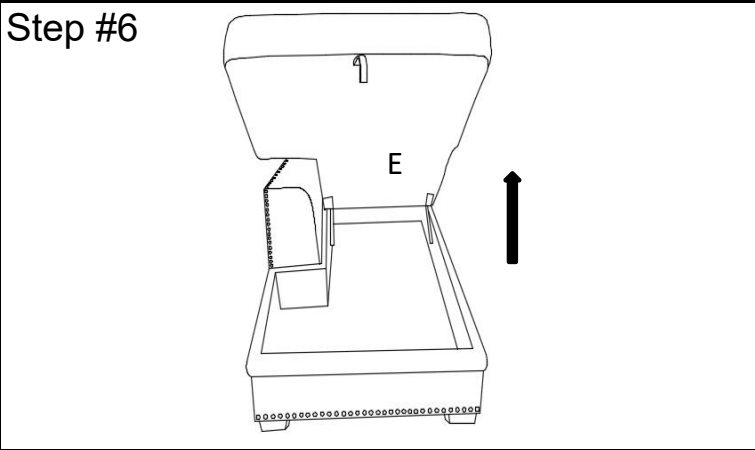
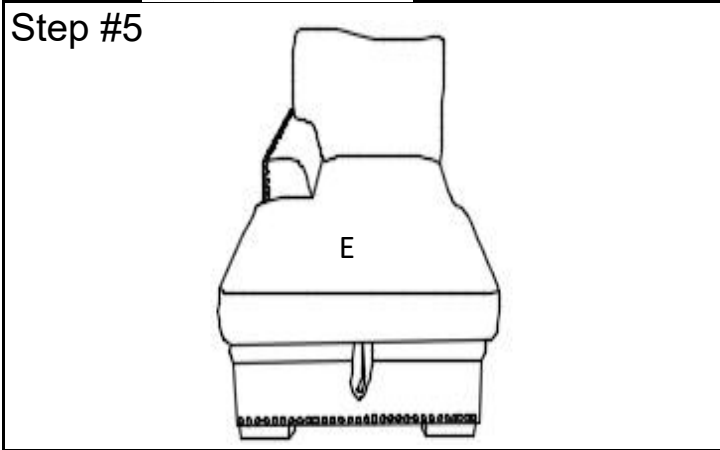
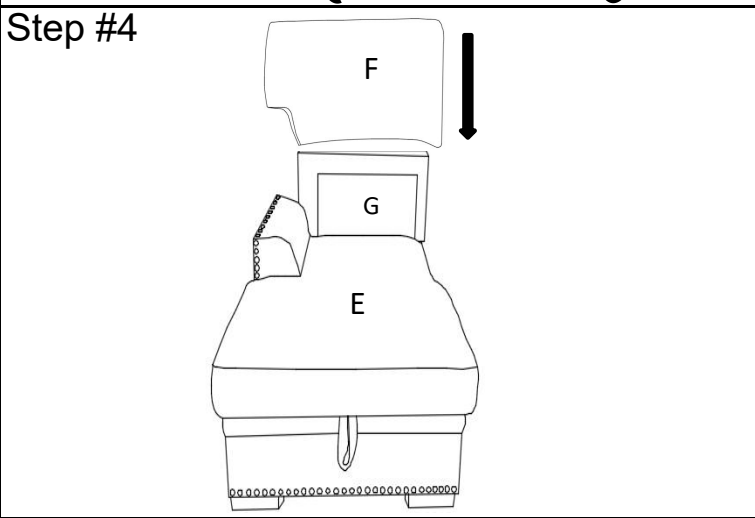
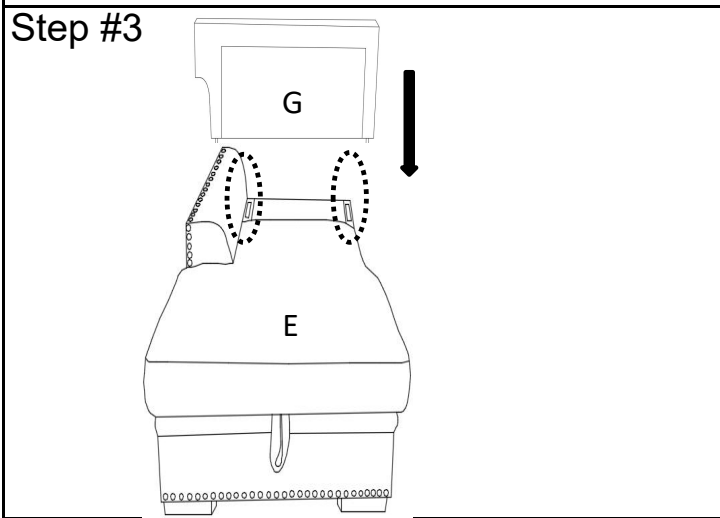
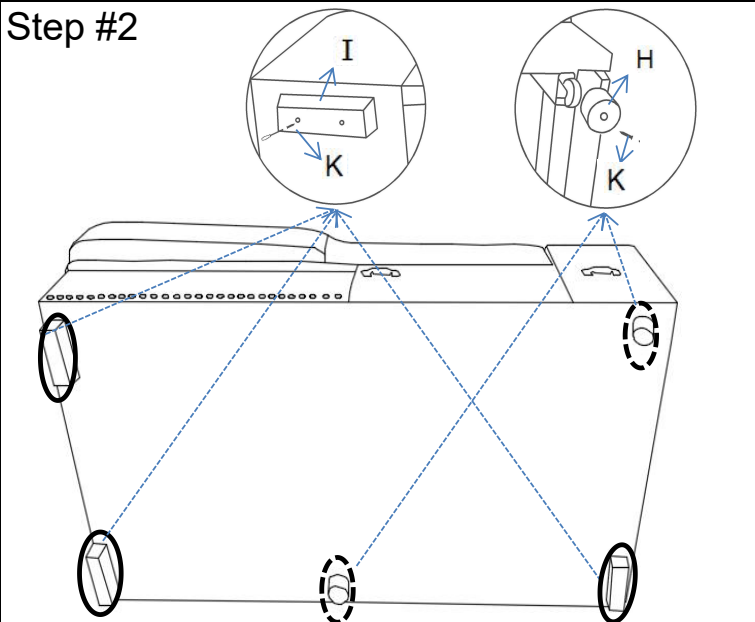
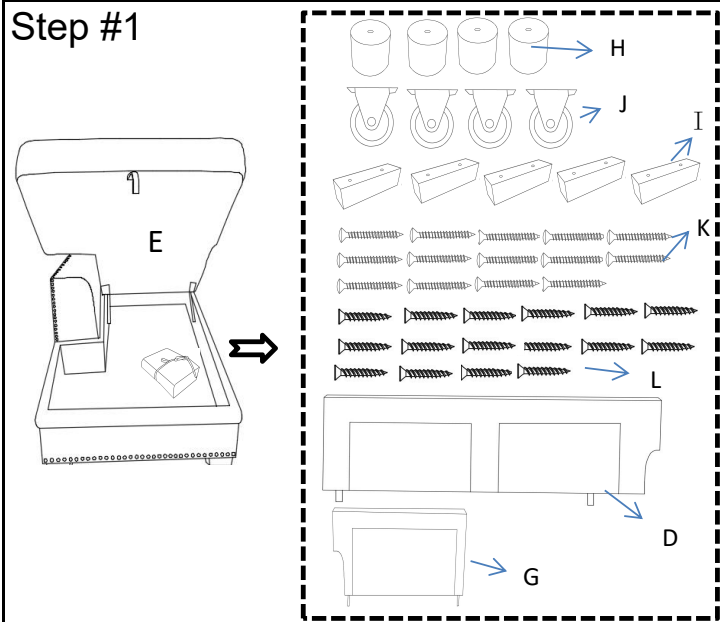

Care Instruction for 100% Polyester Furniture:

In order to maintain the original appearance of your 100% Polyester furniture, please follow below simple care proceures:

- Avoid exposing furniture directly to sunlight or heating and air conditioning outlets. Sunlight and or exposure to heating and air conditioning outlets will fade/damage fabric.
- Vacuum or wipe with a soft cloth to remove dust.



For item use on wooden floor, hard surfaces or carpets, it is recommended to install protective pads under all legs and supports to avoid/prevent from damages/scratches and discoloration.