









# ASSEMBLY INSTRUCTION

**ITEM NO: 9657GY-1PB**

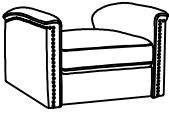
## **PUSH BACK RECLINING CHAIR**

**NOTE: Do not use power tools for assembly. Power tools increase the risk of over tightening which leads to splitting or cracking the wood.**

### **COMPONENT LIST (CHAIR)**

NO.	DRAWING	QTY	DESCRIPTION
A		1	SEAT
B		1	BACK REST
C		1	LSF EAR
D		1	RSF EAR
E		2	FRONT WOODEN LEG (14.5 x 6 x 4CM)
F		2	BACK WOODEN LEG (14.5 x 6 x 4CM)
G		4	WASHERS (Ø4.7CM)

**STEP# 1**

Please find the legs at the bottom of seat (A).

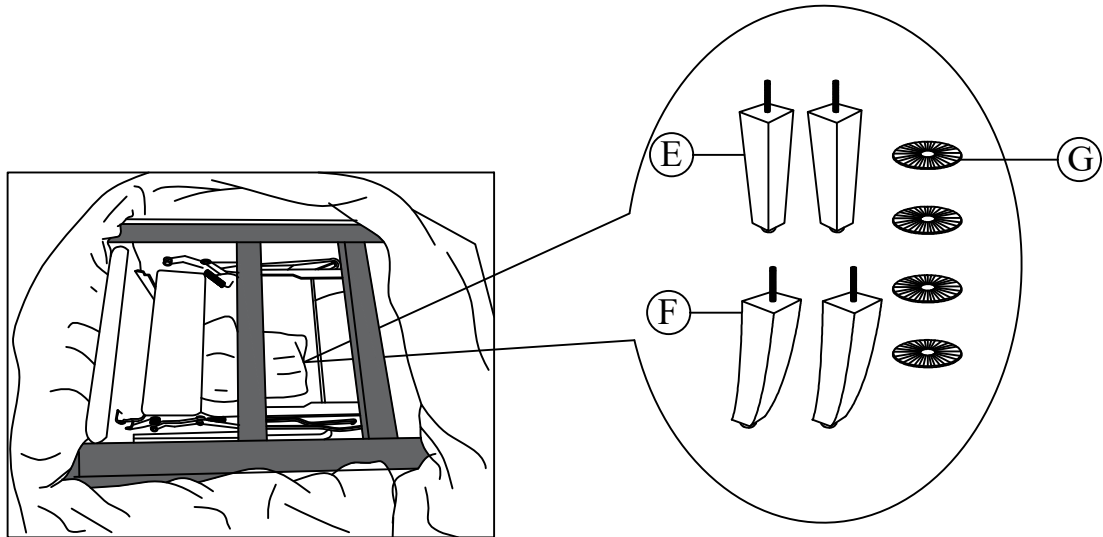

**STEP# 2**

Turn Plastic Leg (D) and Washers (E) until fully tightened.

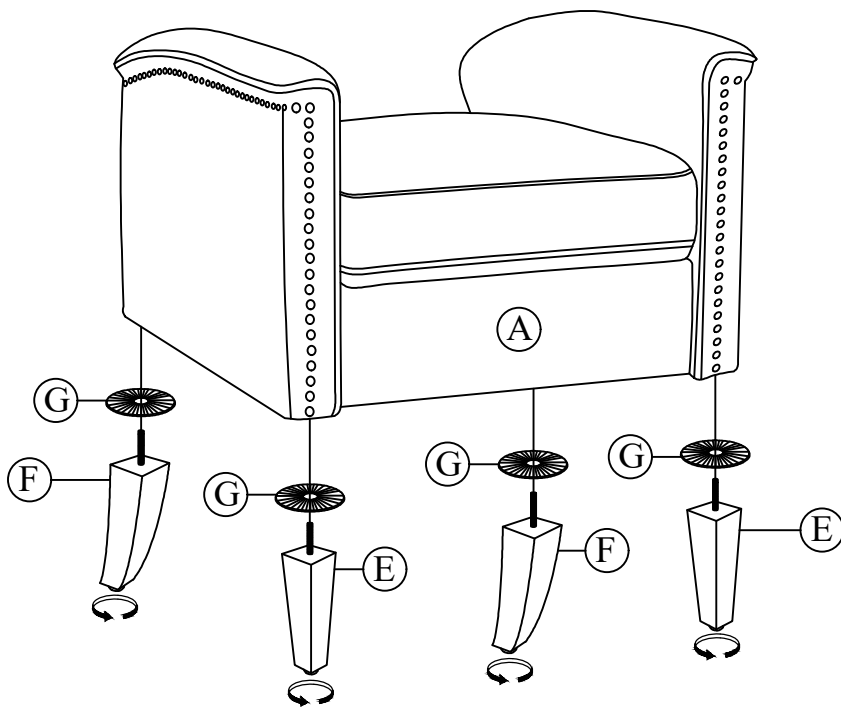

**STEP# 2**

Put the Backrest (B) to the Seat (A).

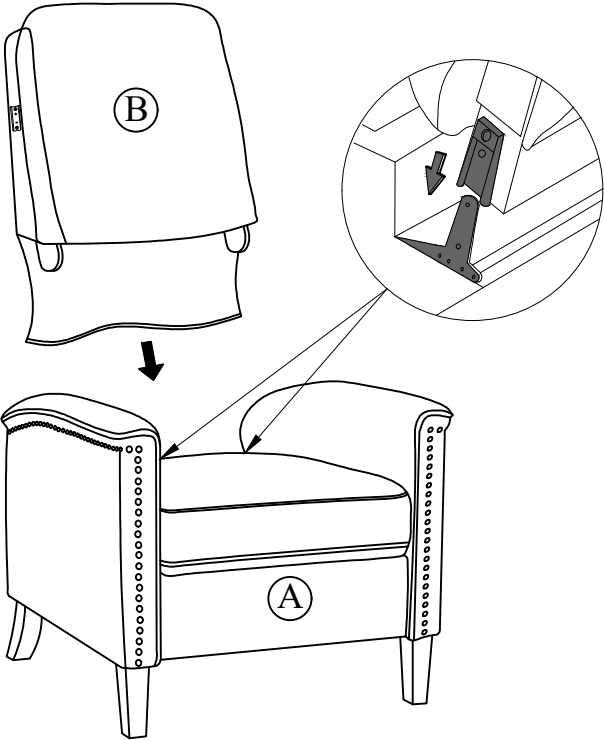

**STEP# 3**

Put the Left Wing (C) and Right Wing (D) on the size of the Backrest (B).

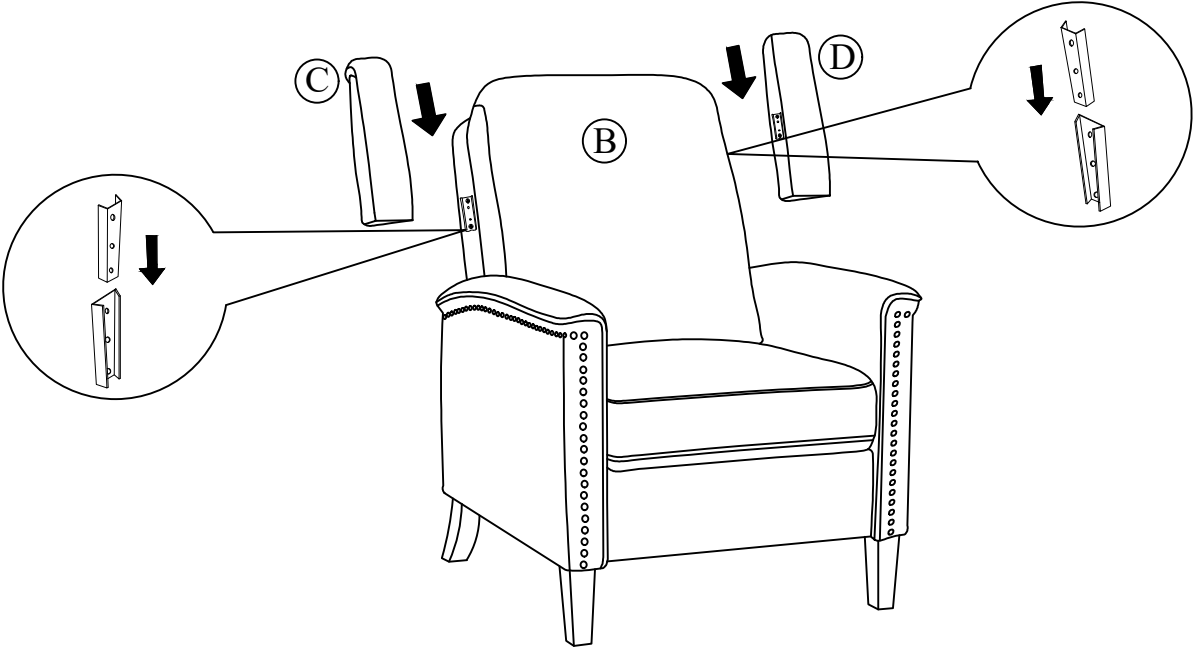

## STEP# 4

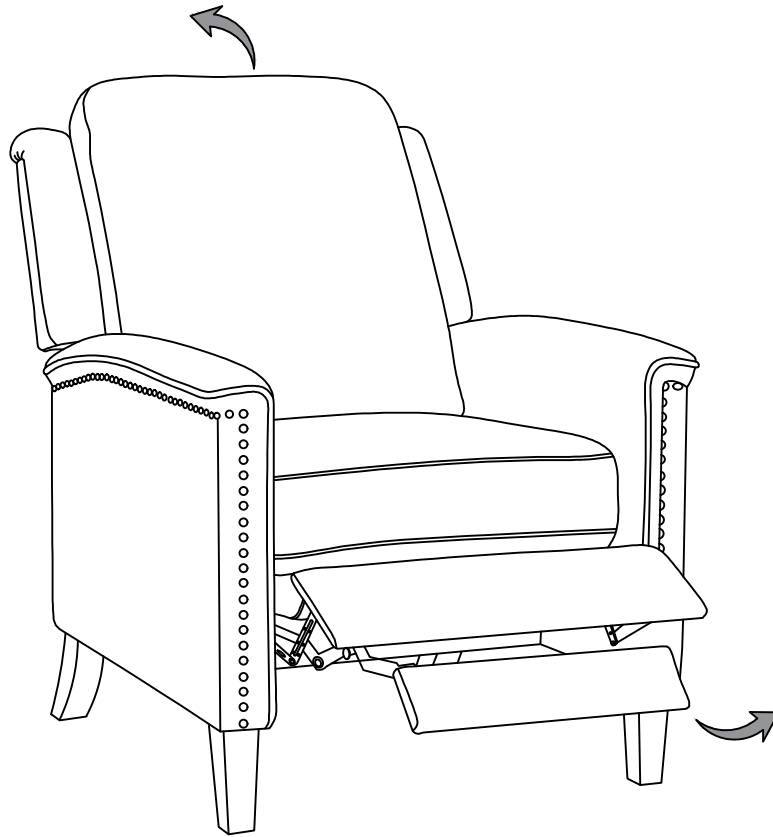

### **Care Instruction for Chenille Furniture.**

In order to maintain the original appearance of your Chenille furniture, please follow below simple care procedures:

- Avoid exposing furniture directly to sunlight or heating and air conditioning outlets. Sunlight and/or exposure to heating and air conditioning outlets will fade/damage Chenille.
- Do not place your Chenille furniture too close to windows , radiators, or vents.
- Vacuum or wipe with a soft brush to remove dust.
- Hardware may loosen over time. Periodically check to make sure all connection are tight, Re-tighten if necessary.



**For items use on wooden floor, hard surfaces or carpets, it is recommended to install protective pads under all legs and supports to avoid/prevent from damages/scratches and discoloration.**