



# Assembly Instruction

ITEM NO: 9720GRY/DGY-3









Sofa



Legs and hardware are stored on the seat, please take them out for assembly.

Note: Do not use power tools for assembly. Power tools increase the risk of over tightening which lead to splitting or cracking the wood.

## Component list

No	Drawing	Qty	Description
A		1	SEAT BASE
B		1	BACKREST
C		3	BACK CUSHIONS
D		3	SEAT CUSHIONS
E		4	PILLOWS (19*19")
F		4	WOODEN LEGS (177*177*45mm)
G		1	CENTER LEG (60*40mm)
H		8	BOLTS 1/4*-20*45MM
I		1	ALLEN KEY 5/ 32mm

# Step 1

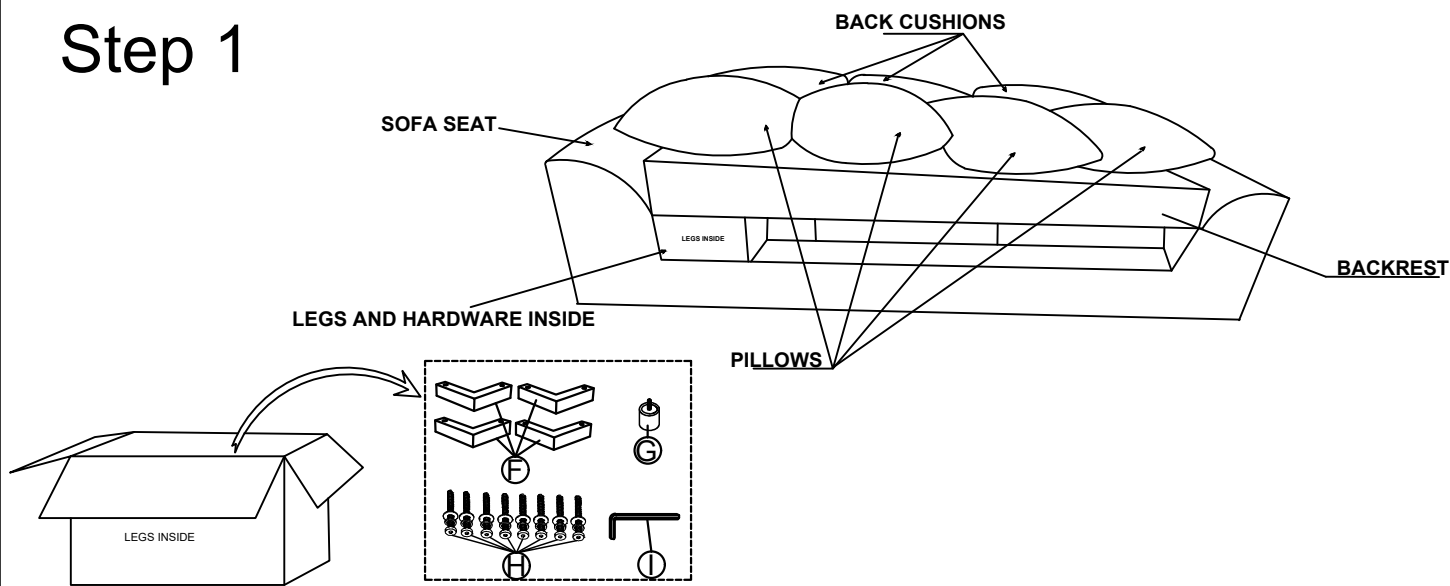

# Step 2

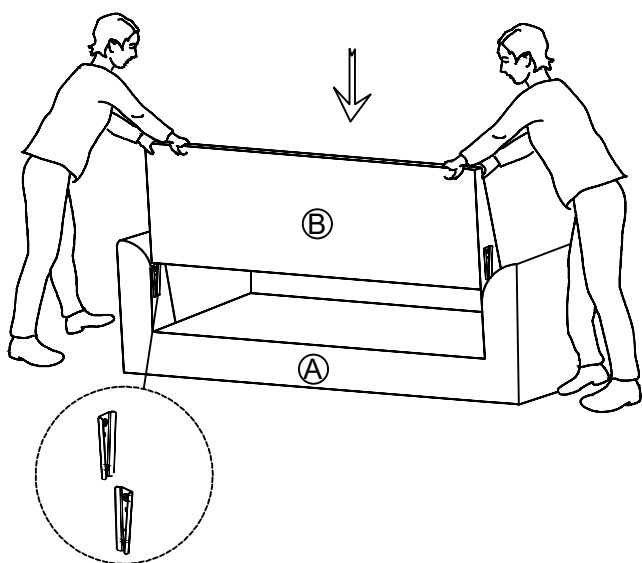

# Step 3

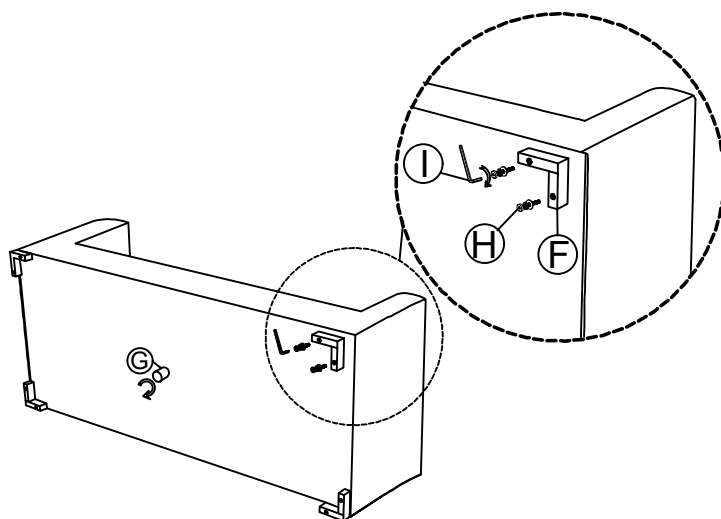

# Step 4

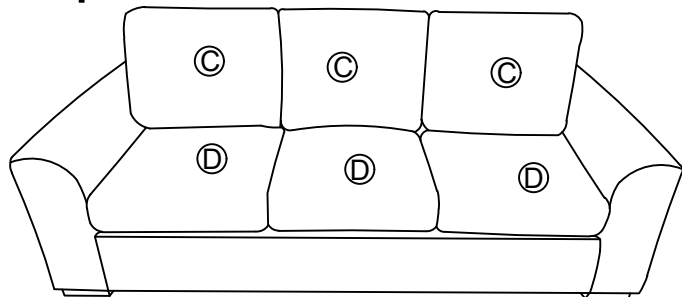

# Completed

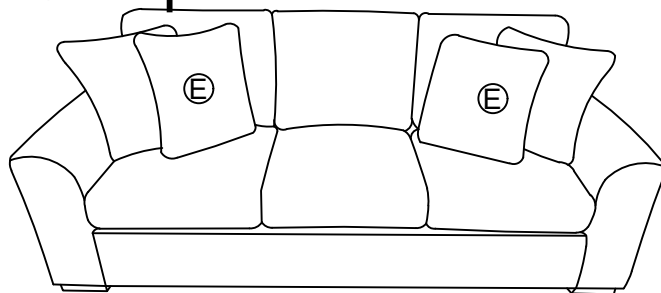

## Care Instruction for Textured Fabric Furniture:

In order to maintain the original appearance of your textured fabric furniture, please follow below simple care procedures:

- Avoid exposing furniture directly to sunlight or heating and air conditioning outlets. Sunlight and/or exposure to heating and air conditioning outlets will fade/damage fabrics. Do not place your upholstered furniture too close to windows, radiators, or vents, and be sure to use windows, radiators, or vents.
- Vacuum or wipe with a soft cloth to remove dust.
- Hardware may loosen over time. Periodically check to make sure all connections are tight. Re-tighten if necessary



For items use on wooden floor, hard surfaces or carpets, it is recommended to install protective pads under all legs and supports to avoid/prevent from damages/scratches and discoloration.